

KOMATSU®

FLYWHEEL HORSEPOWER
858 kW 1,150 HP @ 1800 rpm

OPERATING WEIGHT
152600 kg 336,420 lb

D575A-3 SUPER DOZER



D
575A

CRAWLER DOZER



Photos may include optional equipment.

GALEO

WALK-AROUND

When it comes to crawler dozers, bigger really is better. Bigger dozers are *more efficient*—they push more material per hour, and per shift, for a lower overall cost per yard. Presenting the most efficient of them all—the **Komatsu D575A-3 Super Dozer**. The largest, most productive *dozer* in the world by a factor of nearly two.

Komatsu-integrated design offers industry-leading productivity and reliability, now with additional advanced standard features. Hydraulics, power train, frame, and all other major components are engineered and manufactured by Komatsu. You get a machine whose components are designed to work together for higher production, greater reliability, and improved operator comfort.

858 kW **1,150 HP** turbocharged, aftercooled engine provides plenty of power

Preventative Maintenance

- Centralized Service Station
- Enclosed Hydraulic Piping
- Modular Power Train Design
- Oil Pressure Checking Ports

Large Blade Capacity:

69 m³ 90 yd³



The Super Dozer

The D575A-3 Super Dozer reduces operating costs (\$/tons) by high dozing productivity.

- Large capacity Super Dozer blade with low dozing resistance

Automatic lockup **torque converter** saves fuel and increases speed and power transmitting efficiency on long pushes

Pentagonal Designed Cab includes:

- Spacious interior
- Excellent visibility
- PCCS (Palm Command Control System) lever
- Pressurized cab
- Adjustable armrests

NET HORSEPOWER
858 kW 1,150 HP @ 1800 rpm

OPERATING WEIGHT
152600 kg 336,420 lb

BLADE CAPACITY
69 m³ 90 yd³

Extra-low Machine Profile

provides excellent machine balance
and low center of gravity

ECMV (Electronic Controlled Modulation Valve)

controlled steering clutch/brakes system
facilitates steering operation

***Low-drive, long-track, eight roller undercarriage***

ensures outstanding grading ability
and stability

Photos may include optional equipment.

Resilient Equalized Undercarriage (REU)

improves traction, component durability, and operator comfort

GALEO

Komatsu's highly productive, innovative technology, environmentally friendly machines built for the 21st century.

PCCS (PALM COMMAND CONTROL SYSTEM)

Komatsu's new ergonomically designed control system "PCCS" creates an operating environment with "complete operator control."

Operator-machine Interface

Palm Command Electronic Controlled Travel Control Joystick

Ergonomically designed palm command travel joystick provides the operator with a relaxed posture and superb fine control without operator fatigue. Transmission gear shifting is simply carried out with thumb.

Fully Adjustable Suspension Seat and Travel Control Console



For improved rear visibility during return part of cycle, the operator can adjust seat 15° to the right. The transmission and steering controls move with the seat for best operator comfort.

The travel control console also has adjustment fore and aft and for height, with an independently adjustable armrest. Each D575A operator can adjust control positions to his individual preference.

Outline of Electronic Control System

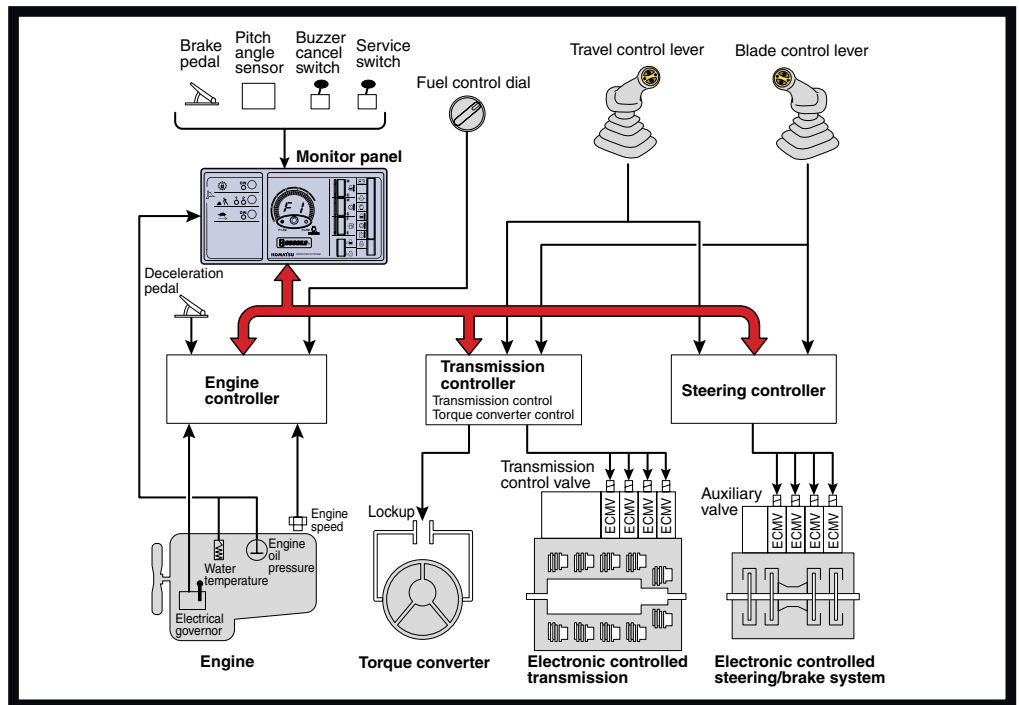

Fuel Control Dial

Engine revolution is controlled by an electric signal, providing ease of operation and reducing problems caused by linkage joint seizure.

Palm Command PPC Controlled Blade Control Joystick

Blade control joystick uses the PPC (Proportional Pressure Control) valve and a palm command joystick the same as a travel control joystick. PPC control combined with the highly reliable Komatsu hydraulic system, enables superb fine control. Pitch operation is enabled by depressing switch with thumb.

Height Adjustable Blade Control Armrest

The blade control armrest is height adjustable without any tools in three stages, providing the operator with firm arm support and ideal armrest positioning.

Electronic Control System

Smooth and Soft Operation

D575A-3 Super Dozer uses a newly designed power train electronic control system. Controller registers the amount of operator control (movements of lever and operation of switches) and machine condition signals from each sensor, and calculates to accurately control the torque converter, transmission, steering clutches and brakes for optimized machine operation. The ease of operation and productivity of the new D575A-3 SD is remarkably improved by numerous new functions.

ECMV (Electronic Controlled Modulation Valve) Controlled Transmission

Controller automatically adjusts each clutch engagement depending on travel conditions such as gear speed, revolution, and shifting pattern. This provides shockless smooth clutch engagement, improved component reliability, expansion of component life, and operator riding comfort.

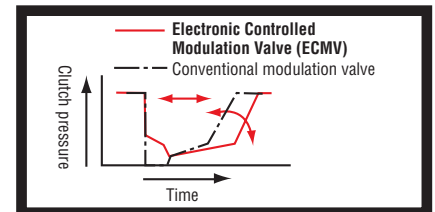

ECMV (Electronic Controlled Modulation Valve) Controlled Steering Clutches/Brakes

Sensors monitor machine operating conditions, and electronically controls steering clutches and brakes depending on type of job, such as size of load during dozing, incline angle of slope or load, providing smooth and ease of operation by reducing counter-steering on downhill travel etc.

Effect of ECMV Steering Clutches/Brake Control

When dozing and turning, ECMV automatically controls stroke ratio of steering clutches and brakes depending on degree of load, enabling smooth dozing and turning.

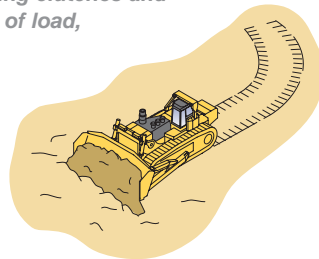

When dozing downhill, ECMV automatically controls steering clutches and brakes depending on incline of machine or degree of load, reducing counter-steering and producing smooth dozing operation.

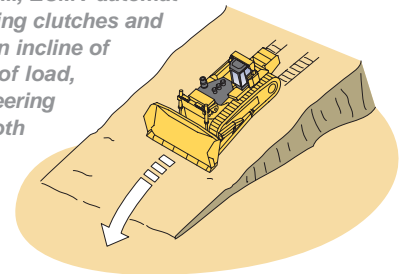

Preset Travel Speed Selection Function

Preset travel speed selection function is standard equipment, enabling the operator to select fore and aft travel speed among three preset patterns such as F1-R2, F2-R2, and manual shift. When F1-R2 or F2-R2 preset pattern is selected, and travel control joystick moves to forward/rearward direction, the machine travels forward/rearward with F1-R2 or F2-R2 speed automatically. This function reduces operating hours and operator's gear shifting time during repeated round-trip operations.

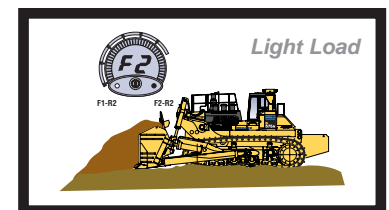
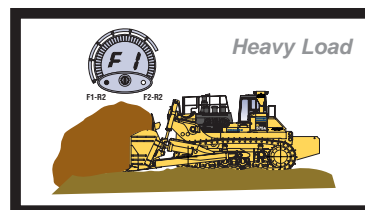
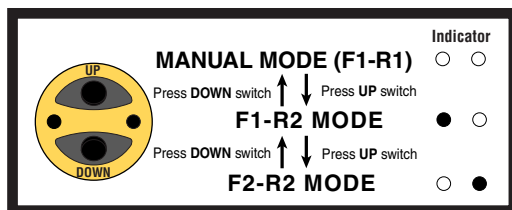

Auto-shift Down Function

Controller monitors engine speed, travel gear, and travel speed. When load is applied and machine travel speed is reduced, the controller automatically shifts down to optimum gear speed to provide high fuel efficiency. This function provides comfortable operation without manual downshift and high productivity (This function can be cancelled with cancel switch).

Actuated on Heavy Load or Steep Load

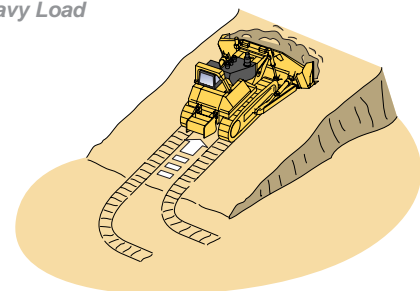

WORKING ENVIRONMENT

Operator Comfort

Operator comfort is essential for safe and productive work. The D575A-3 Super Dozer provides the operator with a quiet, comfortable environment where he can concentrate on the work at hand.

Pentagonal Pressurized Cab

- The large tinted glass windows provide a panoramic view of work area.
- Air filter and a higher internal air pressure combine to prevent dust from entering the cab.

New Suspension Seat

D575A-3 Super Dozer uses a newly designed suspension seat with strengthened seams and breathable fabric. Fore and aft sliding rails and suspension spring are newly designed, increasing strength and rigidity and reducing play of joints. New seat provides excellent support and riding comfort. Fore and aft sliding amount is designed to fit all operators.

Monitor with Self-diagnostic Function

Display for User

In normal operation the monitor displays engine rpm and forward/reverse gear speed on the upper part of the display, and service meter on the lower part of the display.

Continuous Machine Monitoring System

Check-before-starting and caution items appear on the liquid crystal panel and a warning buzzer. The continuous machine condition check helps prevent the development of serious problems and allows the operator to concentrate his attention on the controls.

Abnormalities on Electronics System Display with Code

When an error occurs during operation, user code and service meter are displayed alternately. When a high importance user code is displayed, a caution lamp lights up and a warning buzzer sounds to prevent the development of serious problems.

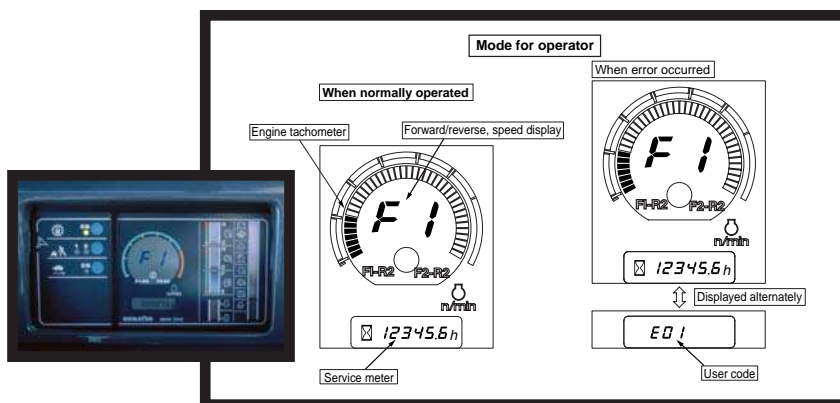

PRODUCTIVITY FEATURES

Engine

The Komatsu SA12V170E engine delivers 858 kW **1,150 HP** at 1800 rpm. The fuel-efficient Komatsu engine, together with the heavy machine weight, makes the D575A-3 Super Dozer a superior crawler dozer in dozing production. The engine is designed to surpass EPA/CARB regulations, and features direct fuel injection, a turbocharger, and an aftercooler to maximize fuel efficiency.

To minimize noise and vibration, the engine is mounted to the main frame with rubber cushions.

Automatic Torque Converter Lockup System

For greater efficiency during long pushes, the lockup mode allows the system to automatically engage the torque converter lockup clutch. Locking up the torque converter transmits all the engine power directly to the transmission, increasing ground speed, thus achieving efficiencies equal to a direct drive. The result is efficient use of engine power, less fuel consumption, and faster cycle times.

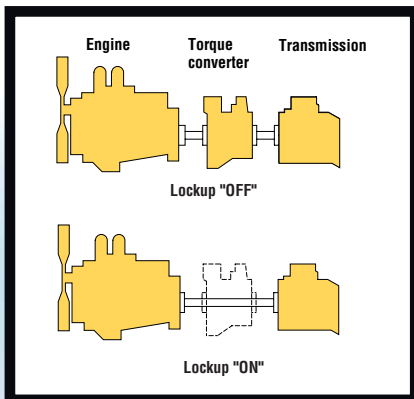

Resilient Equalized Undercarriage (REU)

The REU system provides powerful traction, component durability, and operator comfort. Outstanding traction can be achieved because the shoes always follow the contour of the ground. The X-shaped, bogie-structured resilient equalized undercarriage performs independent see-saw movements. To decrease vibration and shock, rubber shock absorbers are mounted on the X-shaped bogies. The bogies and rubber cushions provide different absorption characteristics depending on the ground surface. When the machine travels on flat ground, the REU functions as a conventional rigid undercarriage. When the machine travels on uneven ground, the REU maximizes the suspension effect.

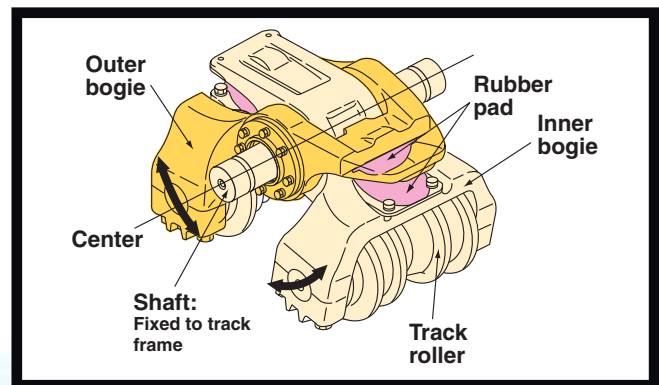

PRODUCTIVITY FEATURES *CONTINUED*

Super Dozer Blade

The 69 m³ 90 yd³ capacity Super Dozer blade yields outstanding production with the innovative Super Dozer blade design, which is 15% more productive in level dozing.

- Blade capacity increased by extra holding volume
- Pushing larger volume of material against the same soil resistance
- Optimum machine balance for dozing

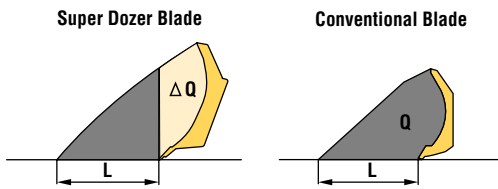

Q = Original blade capacity
ΔQ = Additional holding volume
(ΔQ = 0.15 x Q)
L = Soil resistance

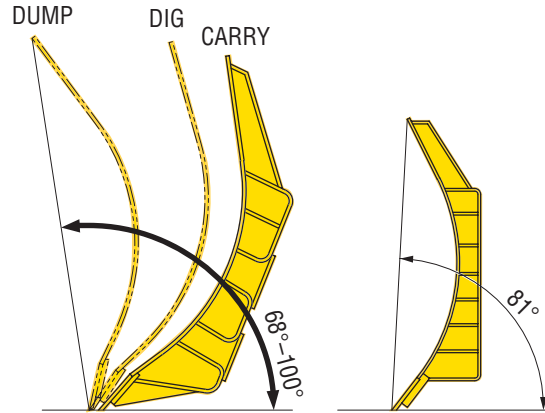

**D575A-3
Super Dozer**
69 m³ 90 yd³

**Conventional
U-Blade**
45 m³ 59 yd³

Unlike ordinary dozer blades, the Super Dozer blade has a full range of movement. Three basic positions—dig, carry, and dump—create previously unheard-of levels of efficiency. It also includes auto-dump and auto-reposition features.



EASY MAINTENANCE

Preventative Maintenance

Preventative maintenance is the only way to ensure long service life from your equipment. That's why Komatsu designed the D575A-3 Super Dozer with conveniently located maintenance points to make necessary inspections and maintenance quick and easy.

Centralized Service Station

To ensure convenient maintenance, all necessary filters are arranged in a centralized service station next to right side of the cab.

Enclosed Hydraulic Piping

Hydraulic piping for the blade tilt and pitch is completely housed in the push arm ensuring protection from materials.

Modular Power Train Design

Power train components are sealed in a modular design that allows the components to be dismantled and mounted without oil spillage, making service work clean, smooth, and easy.

Oil Pressure Check Ports

Pressure check ports for power train components are centralized to promote quick and simple diagnosis.



SPECIFICATIONS



ENGINE

Model Komatsu SA12V170E
 Type 4-stroke, water-cooled, direct injection
 Aspiration Turbocharged, aftercooled
 Number of cylinders 12
 Bore x stroke 170 mm x 170 mm **6.69" x 6.69"**
 Piston displacement 46.3 ltr **2,825 in³**
 Horsepower rating @ 1800 rpm
 Net power (SAE J1349) 858 kW **1,150 HP**
 Governor All-speed, electrical
 Lubrication system
 Method Gear pump, force lubrication
 Filter Full-flow and bypass combined



TORQFLOW TRANSMISSION

Komatsu TORQFLOW transmission consists of an air-cooled, 3-element, 1-stage, 1-phase torque converter with lockup clutch and a planetary gear, multiple-disc clutch transmission which is actuated by ECMV (Electronic Control Modulation Valve) and force-lubricated for optimum heat dissipation.

Gear	Forward		Reverse	
1st	3.7 km/h	2.3 mph	4.3 km/h	2.7 mph
2nd	6.6 km/h	4.1 mph	7.7 km/h	4.8 mph
3rd	11.6 km/h	7.5 mph	13.3 km/h	8.3 mph

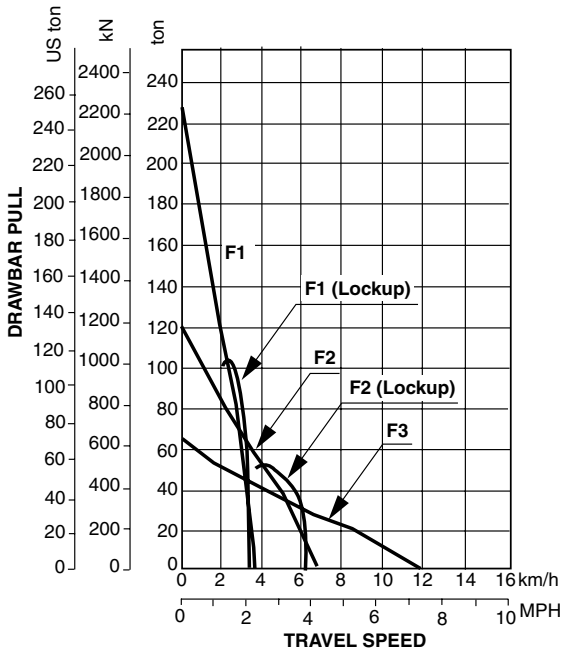

FINAL DRIVES

Triple-reduction final drive uses two-stage spur and single-stage planetary gears (five) to minimize transmission of shock to power train components. Segmented sprocket rims are bolt-on type for easy in-the-field replacement.



STEERING SYSTEM

PCCS lever, joystick-controlled, wet multiple-disc steering clutches are spring-loaded and hydraulically released. Wet multiple-disc, pedal/lever controlled steering brakes are spring-actuated, hydraulically released, and require no adjustment. Steering clutches and brakes are interconnected for easy, responsive steering.



UNDERCARRIAGE

Suspension Oscillating equalizer bar and pivot shaft
 Track roller frame Box-section, high-tensile-strength steel construction
 Rollers and idlers Lubricated track rollers

Resilient equalized undercarriage
 Lubricated track rollers are resiliently mounted to the roller frame with a series of X-type bogies whose oscillating motion is cushioned by rubber pads.

Extreme service track shoes
 Lubricated tracks. Unique seals prevent entry of foreign abrasives into pin to bushing clearances to provide extended service life. Track tension is easily adjusted with grease gun.

Number of shoes (each side) 49
 Grouser height:
 Single grouser 105 mm **4.1"**
 Shoe width (standard) 860 mm **34"**
 Ground contact area 94342 cm² **14,623 in²**
 Ground pressure 159 kPa 1.62 kg/cm² **23.0 psi**
 Number of track rollers (each side) 8
 Number of carrier rollers (each side) 2

Extreme service shoes	Additional weight	Ground contact area	Ground pressure
910 mm 36"	570 kg 1,260 lb	99827 cm ² 15,473 in²	150 kPa 1.53 kg/cm ² 21.8 psi



COOLANT AND LUBRICANT CAPACITY (REFILL)

Fuel tank 2100 ltr **555 U.S. gal**
 Coolant 298 ltr **79 U.S. gal**
 Engine 195 ltr **52 U.S. gal**
 Torque converter, transmission, bevel gear, and steering system 345 ltr **91 U.S. gal**
 Final drive (each side) 160 ltr **42 U.S. gal**



DIMENSIONS

A	3220 mm	10'7"
B	7400 mm	24'3"
C	4495 mm	14'9"
D	3640 mm	11'11"
E	5485 mm	18'0"
F	11720 mm	38'5"
G	2305 mm	7'7"
H	4880 mm	16'0"
I	1750 mm	5'9"
J	805 mm	2'8"
K	1000 mm	3'3"

SUPER DOZER WITH COUNTERWEIGHT

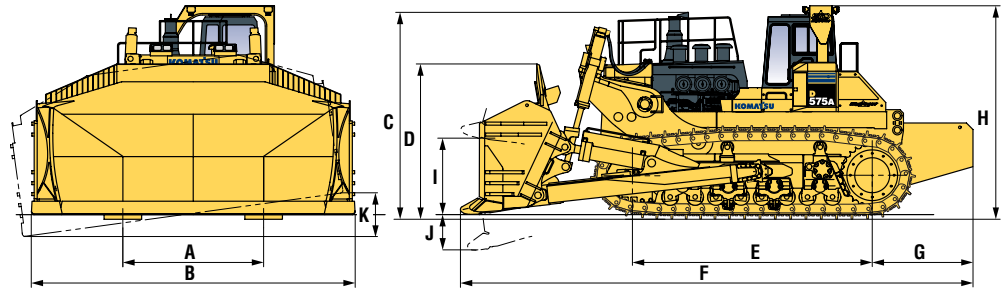

Ground Clearance: 745 mm 2'5"



OPERATING WEIGHT

Tractor weight 114580 kg **252,600 lb**
Including rated capacity of lubricant, coolant, full fuel tank, operator, and standard equipment.

Operating weight. 152600 kg **336,420 lb**
Including Super Dozer blade, counterweight, steel cab, ROPS, operator, standard equipment, rated capacity of lubricant, coolant, and full fuel tank.

Ground pressure 159 kPa 1.62 kg/cm² **23.0 psi**



HYDRAULIC SYSTEM

Hydraulic control unit:
Maximum flow. 1258 ltr/min **332 U.S. gal/min**
Relief valve setting 20.6 MPa 210 kg/cm² **2,990 psi**

- All-spool control valves
- Multi-chamber gear hydraulic pump

Control valves:

- Two control valves [Super Dozer]
Positions: Blade lift Raise, hold, and lower
Blade tilt. Right, hold, and left
Blade pitch Forward, hold, and rearward

Hydraulic cylinders Double-acting, piston type

	Number of cylinders	Bore
Blade lift	2	225 mm 8.86"
Blade tilt and pitch	2	300 mm 11.81"

Hydraulic oil capacity (refill):
Super Dozer 300 ltr **79 U.S. gal**



DOZER EQUIPMENT

Blade capacities are based on the SAE recommended practice J1265.

	Overall length with dozer	Blade capacity	Blade length x height	Maximum lift above ground	Maximum drop below ground	Maximum tilt adjustment	Weight	Ground pressure*
							Dozer equipment	
Super Dozer	10385 mm 34'1"	69 m ³ 90 yd³	7400 mm x 3250 mm 24'3" x 10'8"	1750 mm 5'9"	805 mm 2'8"	1000 mm 3'3"	32430 kg 71,500 lb	159 kPa 1.62 kg/cm ² 23.0 psi

*Ground pressure shows tractor with Super Dozer blade, cab, ROPS canopy, counterweight, operator, and standard equipment.



STANDARD EQUIPMENT

- Air conditioner with heater and defroster
- Alternator, 75 A/24 V
- AM/FM radio
- Auto-priming system
- Back-up alarm
- Batteries, 200 Ah/4 x 12 V
- Blower fan
- Cab pressurizer
- Decelerator pedal
- Dry-type air cleaner with dust evacuator and dust indicator
- Final drive case wear guard
- Hinged front mask
- Hinged underguard with front pull hook
- Hydraulic track adjusters
- Lighting system (including eight front and four rear lights)
- Lockup torque converter
- Muffler with rain cap
- PCCS lever, steering control
- Power tilt, power pitch blade system
- ROPS
- Segmented sprockets
- Semi-automatic blade repositioner
- Shoes, 860 mm 34"
- Starting motors, 2 x 11 kW/24 V
- Steel cab with FOPS
- Suspension seat with seat belt
- TORQFLOW transmission
- Track frames, eight-track-roller
- Track roller guards (center)
- Travel control console integrated with operator seat
- Vandalism protection locks
- Warning horn
- Wet steering clutches



ROPS (FOPS)*:

Weight 1970 kg **4,340 lb**

Roof dimension:

Length 1160 mm **3'10"**

Width 1000 mm **3'3"**

*Meets ISO 3471, SAE J1040, and J395 ROPS standards, as well as ISO 3449 FOPS standards

Steel cab:

Weight 480 kg **1,060 lb**

Dimensions:

Length 1690 mm **5'7"**

Width 1550 mm **5'1"**

Height, floor to ceiling 1560 mm **5'1"**



OPTIONAL EQUIPMENT

- Additional lighting system
- Counterweight, 5400 kg **11,900 lb**
- Fast fuel fill
- Fire extinguisher
- ProVision™ High Precision GPS
- Shoes:
—910 mm **36"**

AESS569-02

©2005 Komatsu Printed in USA

DK05(2.5M)C

05/05 (EV-1)

KOMATSU®

440 N. Fairway Drive
P.O. Box 8112
Vernon Hills, IL 60061-8112