

KOMATSU®

WA380-6

WA
380

HORSEPOWER

Gross: 143 kW 192 HP / 2100 min⁻¹

Net: 142 kW 191 HP / 2100 min⁻¹

OPERATING WEIGHT

17510 – 18570 kg

BUCKET CAPACITY

2.7 – 4.0 m³



Photos may include optional equipment.

WALK-AROUND





HIGH PRODUCTIVITY & LOW FUEL CONSUMPTION

- ▮ Precision Control with Closed-center Load Sensing System (CLSS) Hydraulics
- ▮ Faster Travel & Lower Fuel Consumption
- ▮ Maximum Dumping Clearance and Reach

INCREASED RELIABILITY

- ▮ Komatsu Designed Components
- ▮ High-rigidity Frames and Loader Linkage
- ▮ Wet Multiple-disc Brakes and Fully Hydraulic Braking System

EXCELLENT OPERATOR ENVIRONMENT

- ▮ Pillar-less Large Cab
- ▮ Best Position for Comfort
- ▮ Automatic Transmission with Electronically Controlled Modulation Valve
- ▮ Variable Transmission Cut-Off

EASY MAINTENANCE

- ▮ Maintenance Accessibility
- ▮ Equipment Management Monitoring System
- ▮ Easy Radiator Cleaning

SAFETY

- ▮ ROPS/FOPS Cab (ISO 3471/ISO 3449)
- ▮ Rear-hinged Full Open Cab Door

KOMTRAX

- ▮ KOMTRAX

WA380-6

HORSEPOWER	Gross: 143 kW 192 HP / 2100 min ⁻¹
	Net: 142 kW 191 HP / 2100 min ⁻¹
OPERATING WEIGHT	17510 – 18570 kg
BUCKET CAPACITY	2.7 – 4.0 m ³

HIGH PRODUCTIVITY & LOW FUEL CONSUMPTION



Precision Control with Closed-center Load Sensing System (CLSS) Hydraulics

The WA380-6 features variable-displacement pumps on both the hydraulic and steering systems. These pumps deliver the exact amount of oil required, dramatically improving fuel efficiency. Komatsu's Closed-center load sensing system (CLSS) hydraulics enables extremely precise control of the working gear, and ensures that the bucket, boom and hydraulically driven attachments can all move smoothly at the same time.

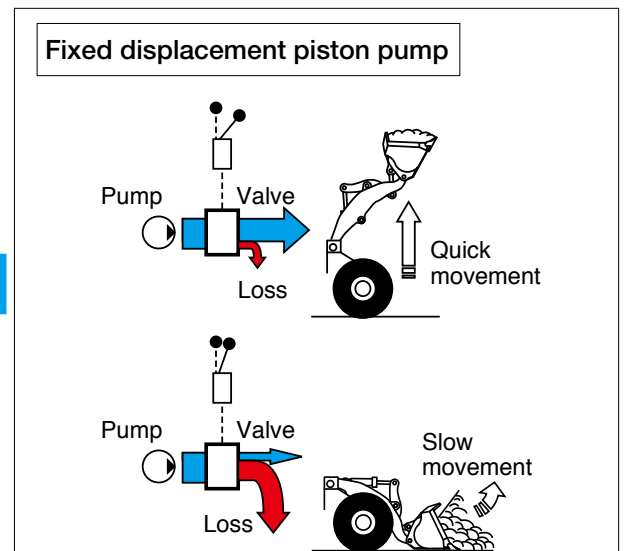
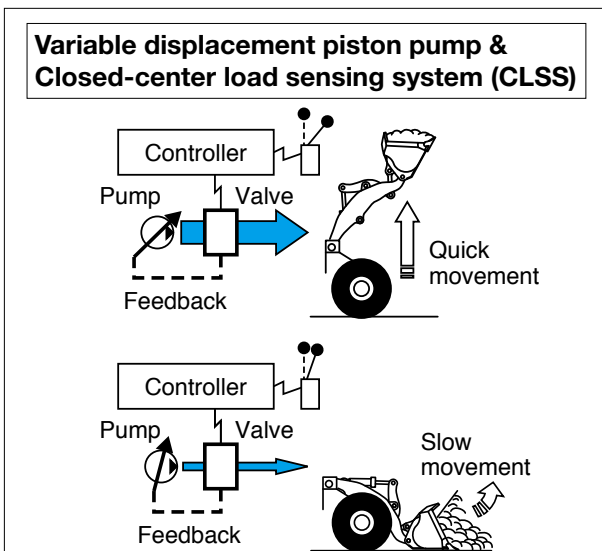

Faster Travel & Lower Fuel Consumption

- **High performance SAA6D107E-1 engine**

Electronic Heavy Duty Common Rail fuel injection system provides optimum combustion of fuel. This system also provides fast throttle response to match the machine's powerful tractive effort and fast hydraulic response.

Net: 142 kW 191 HP

- **Low emission engine**

This engine is EPA Tier 3 and EU Stage 3A emissions certified, without sacrificing power or machine productivity.

- **Low fuel consumption**

The fuel consumption is reduced greatly because of the low-noise, high-torque engine and the large-capacity torque converter with maximum efficiency in the low-speed range.

- **Dual-mode engine power select system**

This wheel loader offers two selectable operating modes—E and P. The operator can adjust the machine's performance with the selection switch.

- **E mode:** This mode provides maximum fuel efficiency for most of general loading.

- **P mode:** This mode provides maximum power output for hard digging operation or hill climb.



Dual mode engine power selection switch

- **Eco indicator**

The Eco Indicator will inform the operator when the machine is maximizing fuel efficiency.



Eco indicator

- **Automatic transmission with mode select system**

This operator controlled system allows the operator to select manual shifting or two levels of automatic shifting (low, and high).

Auto L mode is for fuel saving operation with the gear shift timing set at lower speeds than Auto H mode. Therefore Auto L mode keeps the engine run in a relatively low rpms range for fuel conservation while yielding adequate tractive force by depressing the accelerator pedal.



Shift mode selection switch

- **Lock-up torque converter (Optional)**

The Komatsu designed lock-up torque converter provides increased production efficiency, reduced cycle times and optimum fuel savings in load & carry or hillclimb operations. This optional feature allows the operator to activate the system on/off with a switch located on the right-side control panel.

Maximum Dumping Clearance and Reach

The long lift arms provide high dumping clearances and maximum dumping reach. The operator can even level loads on the body of a dump truck easily and efficiently.

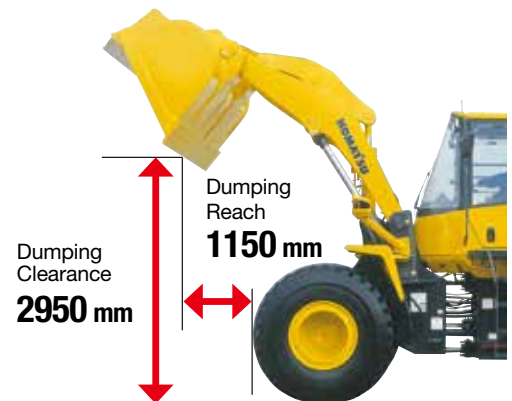

(3.3m³ bucket with Bolt on cutting edge (B.O.C.))

INCREASED RELIABILITY



Komatsu Designed Components

Komatsu manufactures the engine, torque converter, transmission, hydraulic units and electric parts on this wheel loader. Komatsu loaders are manufactured with an integrated production system under a strict quality control system.

High-rigidity Frames and Loader Linkage

The front and rear frames along with the loader linkage have high rigidity to withstand repeated twisting and bending loads to the loader body and linkage. Both the upper and lower center pivot bearings use tapered roller bearings for increased durability.

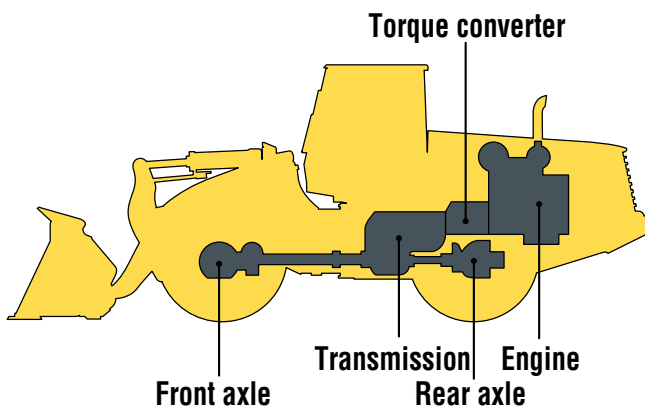

Wet Multiple-disc Brakes and Fully Hydraulic Braking System

This system results in lower maintenance costs and higher reliability. Wet disc brakes are fully sealed. Contaminants are kept out, reducing wear and resulting maintenance. Brakes require no adjustments for wear, meaning even lower maintenance. The new parking brake is also an adjustment-free, wet multi-disc for high reliability and long life. Added reliability is designed into the braking system by the use of two independent hydraulic circuits. Provides hydraulic backup should one of the circuits fail. Fully hydraulic brakes mean no air system to bleed, or the condensation of water in the system that can lead to contamination, corrosion, and freezing.

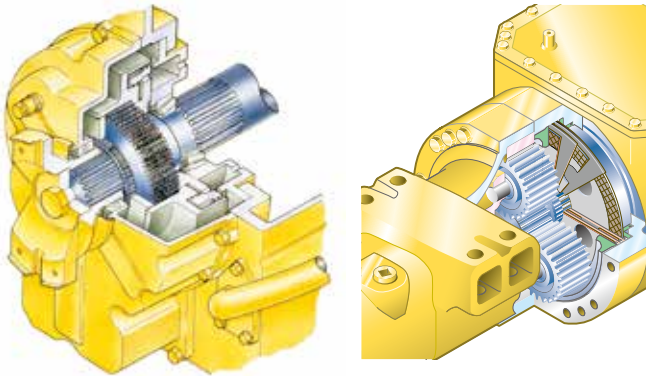

Reliable Hydraulic Line

- Flat face-to-face o-ring seals**
 Flat face-to-face O-ring seals are used to securely seal hydraulic hose connections and to prevent oil leakage.
- Buffer rings**
 In addition, buffer rings are installed to the head side of the all-hydraulic cylinders to lower the load on the rod seals and maximize the reliability.

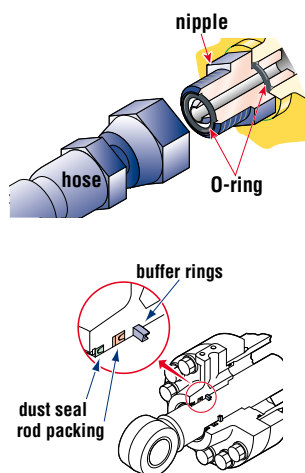

Sealed Connectors

Main harnesses and controller connectors are equipped with sealed connectors providing high reliability, water resistance and dust resistance.



Komatsu Developed Engine

Komatsu SAA6D140E-5 engine with high pressure common rail injection delivers ample power in a fuel efficient way. The engine meets EU Stage 3A and EPA Tier 3 emissions regulations. WA380-6's Komatsu SAA6D140E-5 engine features higher torque, better performance at low speed, excellent throttle response and advanced electronics.

- High Pressure Common Rail (HPCR) fuel injection system**

A high pressure pump pumps fuel into "Common Rail". An Electronic Control Unit (ECU) then optimizes fuel injection from the common rail into the engine cylinders. This improves engine power and fuel efficiency, reducing emission and noise levels.



EXCELLENT OPERATOR ENVIRONMENT



The largest in its class, the space cab offers exceptional driver's comfort - comparable to a passenger car. The large, frameless window gives an unobstructed view of the bucket and tires while the slanted rear end ensures a clear view to the rear. The low-noise designed cab with the air-cushioned seat and the fully adjustable console inside allow the operator to work comfortably and productively over long period.

Pillar-less Large Cab

A wide pillar-less flat glass provides excellent front visibility. The wiper arm covers a large area to provide great visibility even on rainy days. The cab area is the largest in its class providing maximum space for the operator. Increased seat slide adjustment to backward by introducing front mounted air conditioner unit.



Low-noise Design

The large cab is mounted with Komatsu's unique ROPS/FOPS (ISO 3471/ISO 3449) viscous mounts. The low-noise engine, hydraulically driven fan, and hydraulic pumps are mounted with rubber cushions, and the cab sealing is improved to provide a quiet, low-vibration, dustproof with pressurizing, and comfortable operating environment.



Best Position for Comfort

• Telescopic/tilt steering column

The operator can both tilt and telescope the steering wheel to allow maximum comfort and control.



- ① Tilt adjustment
- ② Telescopic adjustment

• Fingertip work equipment control levers with large size arm rest

New Pressure Proportional Control (PPC) control levers are used for the work equipment. The operator can easily operate the work equipment with fingertip control, reducing operator fatigue and increasing controllability.

The PPC control lever column can be slid forward or rearward and the large size arm rest can be adjusted up or down to provide the operator with a variety of comfortable operating positions.



Automatic Transmission with Electronically Controlled Modulation Valve

Automatic transmission with Electronically Controlled Modulation Valve automatically selects the proper gear speed based on travel speed, engine speed, and other travel conditions. The Electronically Controlled Modulation Valve system engages the clutch smoothly to prevent lags and shocks when shifting. This system provides efficient machine operation and a comfortable ride.

• Kick-down switch

Consider this valuable feature for added productivity. With the touch of a finger, the kick-down switch automatically downshifts from second to first when beginning the digging cycle. It automatically upshifts from first to second when the direction control lever is placed in reverse. This results in increased rim pull for better bucket penetration and reduced cycle times for higher productivity.

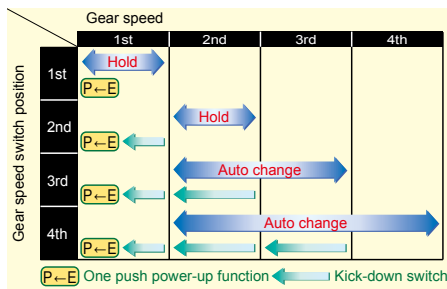

• One push power-up function

The kick-down switch also functions as a power-up switch in first gear. The first time the kick-down switch is depressed, it functions as a kick-down switch and gear speed is reduced. When the machine is in E operation mode and first gear, pressing the kick-down switch a second time changes the operation mode to P allowing increased power for heavy digging operation. The operation mode returns to E when machine gear speed changes or direction changes to reverse.

• Hold switch

Auto shift is selected and if the operator turns on this switch when the lever is at the 3rd or 4th gear speed position, the transmission is fixed to that gear speed.

Electrically Controlled Transmission Levers

The Komatsu two-lever electronic shift control levers provide easy gear selection and directional changes. The transmission levers can be operated without removing the operator's hand from the steering wheel, allowing improved comfort and control. Solid state electronics and conveniently located direction and gear shift controls make this possible. Automatic shifts in ranges two through four keep production high and manual shifting at a minimum.



Variable Transmission Cut-Off

The operator can select the transmission cut-off pressure desired for the left brake pedal using the switch located on the right-side control panel.

- Higher cut-off pressure allows the transmission to remain engaged at higher engine rpm/hydraulic pressure for increased performance in ramp loading and stockpiling operations.
- Lower cut-off pressure disengages the transmission at lower rpm/hydraulic pressure for more fuel efficient operation on level surfaces.



1: Cut-off ON/OFF switch
2: Cut-off adjustment switch
3: Fan reverse ON/OFF switch
4: Boom control
5: Bucket control

Option

• Joystick steering

A joystick steering system is available as option equipment, and ensures that steering can be wrist operated easily and conveniently in loading operations. This system allows you to change the direction of travel and gear shifting with push buttons on the joystick. And you may pre-select the steering speed in 2 stages, depending upon whether fast V-loading or precise Load & Carry is required.



Actual machine may differ from photo.

• Electronically Controlled Suspension System

Electronically Controlled Suspension System uses an accumulator which absorbs some of the shock in the boom arm, giving the operator a much smoother ride. This reduces operator fatigue and reduces material spillage during load and carry operations. Electronically Controlled Suspension System operation is speed sensitive and turned off automatically below 5 km/h speed, meaning that the boom won't move during stationary digging.

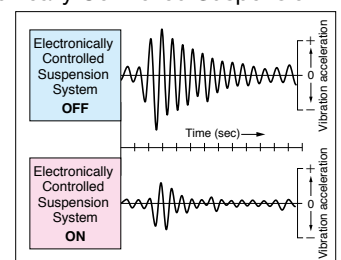

* Image is for illustration purpose

EASY MAINTENANCE



Gull-wing side doors upper stop position

Maintenance Accessibility

- **Designed to save time**

With long service intervals and best-in-class accessibility, the WA380-6 reduces the time and money you need to spend on maintenance. A gas spring helps the operator open and close each gull-wing side door for easy daily servicing. The doors open in two steps and be able to use upper or lower stop position as the situation demands.

- **Simple and convenient access to service**

The service doors are designed as gull-wing doors. They allow you convenient and safe access to the daily service points from the ground.

- **Centralised filter arrangement**

With all filters collected into a centralised arrangement, the down time for servicing is reduced to a minimum.

- **External fluid drains**

All fluids can be drained through externally mounted valves for easy maintenance and reduced spillage.



Gull-wing side doors lower stop position



Equipment Management Monitoring System

Komatsu's new main monitor keeps the operator informed of all machine functions at a glance. The monitor is located behind the steering wheel and displays different machine functions including fluid/filter change intervals and troubleshooting memory display functions. The main gauges are analog type for easy viewing and other functions utilize lighted symbols or Liquid Crystal Display (LCD) readouts.

- **Maintenance control and troubleshooting functions**
 - **Action code display function:** If an abnormality occurs, the monitor displays action details on the character display at the bottom center of the monitor.
 - **Monitor function:** Controller monitors engine oil level, pressure, coolant temperature, air cleaner clogging, etc. If controller finds abnormalities, the error is displayed on LCD.
 - **Replacement time notice function:** Monitor informs replacement time of oil and filters on LCD when replacement intervals are reached.
 - **Trouble data memory function:** Monitor stores abnormalities for effective troubleshooting.



Easy Radiator Cleaning

If the machine is operating in adverse conditions, the operator can reverse the hydraulic cooling fan from inside the cab by pressing a switch on the control panel.

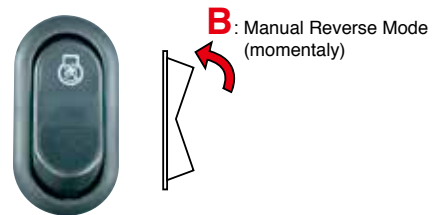

- **Automatic reversible fan (Optional)**

The engine fan is driven hydraulically and can be operated in reverse automatically. When the switch is in the automatic position, the fan revolves in reverse for 2 minutes every 2 hours intermittently (default setting).

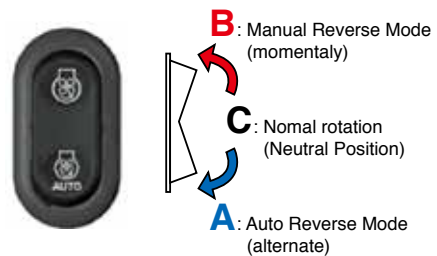



ROPS/FOPS Cab

The ROPS/FOPS Cab is standard for operator's safety. A wide pillar-less flat glass provides excellent front visibility, and a heated rear window provides excellent rear visibility in cold and freezing weather conditions.

ROPS (ISO 3471) : Roll-over Protective Structure

FOPS (ISO 3449) : Falling Objects Protective Structure



Rear-hinged Full Open Cab Door

The cab door hinges are installed to the rear side of the cab providing a large opening angle for the operator to enter and exit. The steps are designed like a staircase, so that the operator can get on and off the cab easily.



Left or Right Side Cab Entry

The operator can get on and off the machine from either side of the vehicle. This design is convenient when getting on and off in a narrow jobsite or on uneven ground.

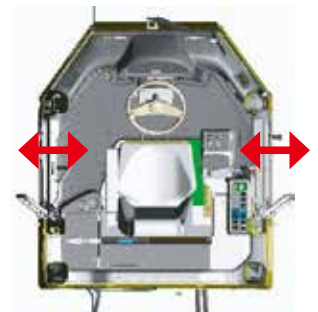

Safety Features

- **Secondary steering**
If the steering pump is disabled, a secondary steering pump provides hydraulic flow.
- **Two independent lines brake system**
Added reliability is designed into the braking system by the use of two independent hydraulic circuits, providing hydraulic backup should one of the circuits fail.
- **Battery disconnect switch**
The battery disconnect switch is located in the right side battery box. This can be used to disconnect power when performing service work on the machine.

KOMTRAX

The Komatsu remote monitoring and management technology provides insightful data about your equipment and fleet in user-friendly format.

Energy Saving Operation Report

KOMTRAX delivers the energy-saving operation report based on the operating information such as fuel consumption, load summary and idling time, which helps you efficiently run a business.



This report image is an example of hydraulic excavator

Equipment Management Support

Through the web application, a variety of search parameters are available to quickly find information about specific machines based on key factors. Moreover, KOMTRAX finds out machines with problems from your fleet and shows you through an optimal interface.

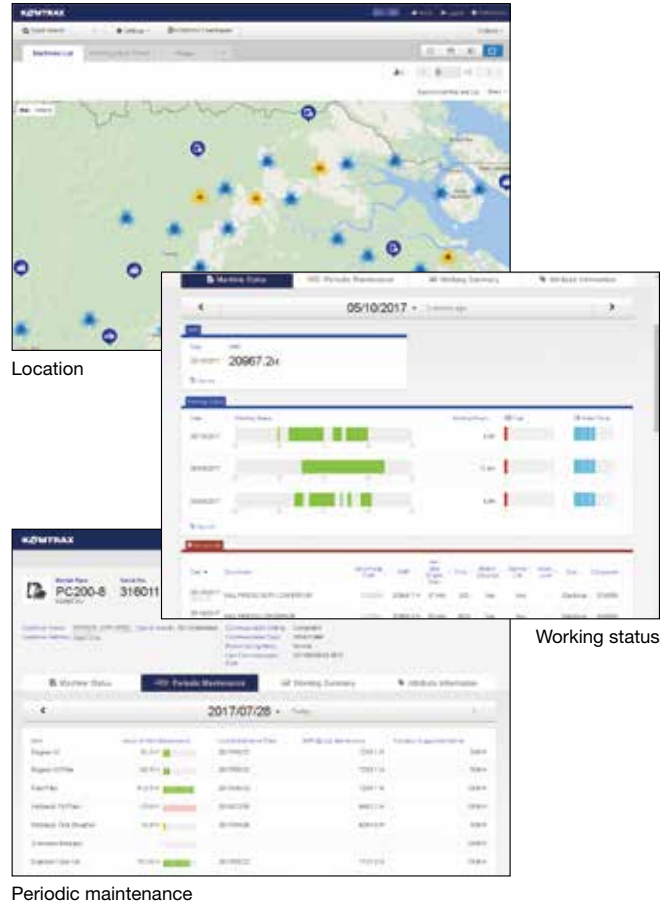

The report contents and data depend on the machine model.

Optimal Strategy for Efficient Work

The detailed information that KOMTRAX puts at your fingertips helps you manage your fleet conveniently on the web anytime, anywhere. It gives you the power to make better daily and long-term strategic decisions.





DIMENSIONS

Measured with 23.5-25-16PR (L-3) tires

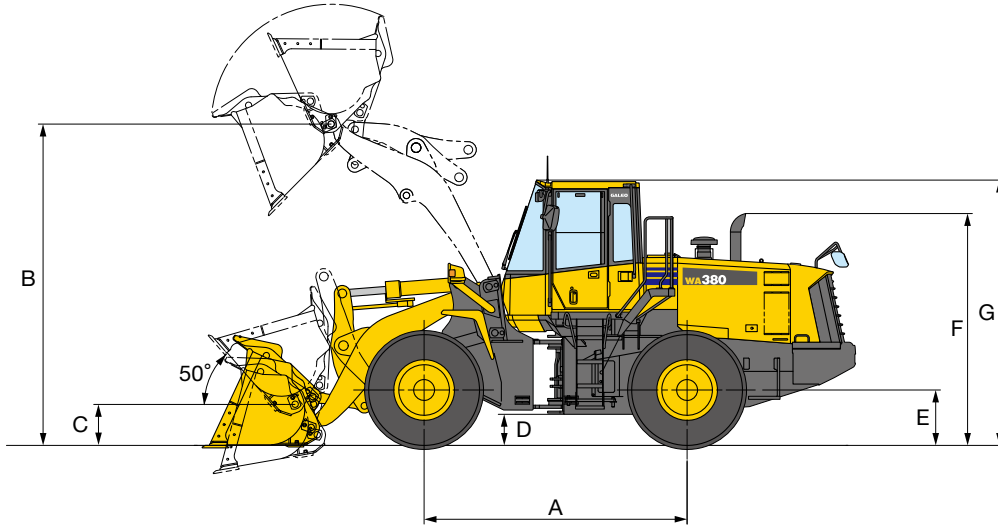

	Standard Boom	High Lift Boom
Tread	2160 mm	
Width over tires	2775 mm	
A Wheelbase	3300 mm	
B Hinge pin height, max. height	4095 mm	4625 mm
C Hinge pin height, carry position	520 mm	680 mm
D Ground clearance	455 mm	455 mm
E Hitch height	1150 mm	1150 mm
F Overall height, top of the stack	2975 mm	2975 mm
G Overall height, ROPS cab	3390 mm	3390 mm

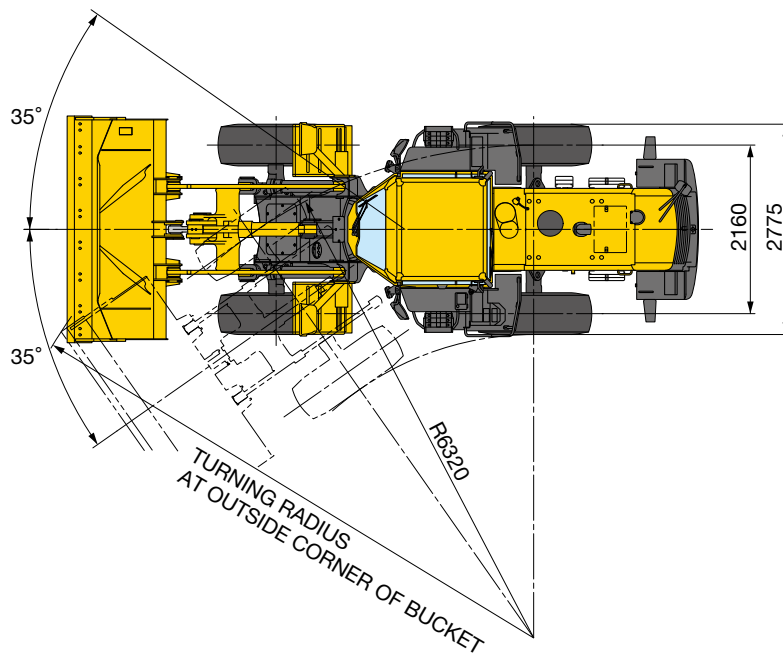



DIMENSIONS

Measured with 23.5-25-16PR (L-3) tires

Standard Boom	General Purpose Buckets		Excavating Bucket			Loose Material Bucket	Light Material Bucket	
	Bolt-on Cutting Edges	Teeth	Bolt-on Cutting Edges	Teeth and Segments	Teeth	Bolt-on Cutting Edges	Bolt-on Cutting Edges	
Bucket capacity:	heaped	3.3 m ³	3.1 m ³	2.9 m ³	2.9 m ³	2.7 m ³	3.6 m ³	4.0 m ³
	struck	2.9 m ³	2.7 m ³	2.4 m ³	2.4 m ³	2.3 m ³	3.0 m ³	3.4 m ³
Bucket width	2950 mm	2925 mm	2905 mm	2925 mm	2925 mm	2905 mm	2905 mm	
Bucket weight	1620 kg	1540 kg	1720 kg	1765 kg	1645 kg	1735 kg	1835 kg	
Dumping clearance, max. height and 45° dump angle*	2950 mm	2820 mm	3045 mm	2925 mm	2925 mm	2920 mm	2855 mm	
Reach at max. height and 45° dump angle*	1150 mm	1245 mm	1055 mm	1155 mm	1155 mm	1170 mm	1240 mm	
Reach at 2130 mm clearance and 45° dump angle	1735 mm	1775 mm	1680 mm	1730 mm	1730 mm	1750 mm	1780 mm	
Reach with arm horizontal and bucket level	2590 mm	2750 mm	2450 mm	2620 mm	2620 mm	2625 mm	2715 mm	
Operating height (fully raised)	5600 mm	5600 mm	5470 mm	5470 mm	5470 mm	5650 mm	5720 mm	
Overall length	8140 mm	8310 mm	8000 mm	8170 mm	8170 mm	8175 mm	8265 mm	
Loader clearance circle (bucket at carry, outside corner of bucket)	14440 mm	14550 mm	14370 mm	14480 mm	14480 mm	14460 mm	14500 mm	
Digging depth:	0°	60 mm	75 mm	60 mm	75 mm	75 mm	60 mm	60 mm
	10°	290 mm	330 mm	265 mm	310 mm	310 mm	300 mm	315 mm
Static tipping load:	straight	14560 kg	14660 kg	14460 kg	14400 kg	14555 kg	14450 kg	14330 kg
	40° full turn	12610 kg	12700 kg	12505 kg	12440 kg	12595 kg	12490 kg	12375 kg
Breakout force	158 kN	170 kN	176 kN	183 kN	191 kN	150 kN	144 kN	
Operating weight	17580 kg	17510 kg	17690 kg	17730 kg	17610 kg	17700 kg	17810 kg	

High Lift Boom	Excavating Bucket			
	Bolt-on Cutting Edges	Teeth and Segments	Teeth	
Bucket capacity:	heaped	2.9 m ³	2.9 m ³	2.7 m ³
	struck	2.4 m ³	2.4 m ³	2.3 m ³
Bucket width	2905 mm	2925 mm	2925 mm	
Bucket weight	1720 kg	1765 kg	1645 kg	
Dumping clearance, max. height and 45° dump angle*	3575 mm	3455 mm	3455 mm	
Reach at max. height and 45° dump angle*	1185 mm	1285 mm	1285 mm	
Reach at 2130 mm clearance and 45° dump angle	2205 mm	2260 mm	2260 mm	
Reach with arm horizontal and bucket level	2940 mm	3110 mm	3110 mm	
Operating height (fully raised)	5985 mm	5985 mm	5985 mm	
Overall length	8760 mm	8930 mm	8930 mm	
Loader clearance circle (bucket at carry, outside corner of bucket)	14850 mm	14930 mm	14930 mm	
Digging depth:	0°	110 mm	125 mm	125 mm
	10°	320 mm	365 mm	365 mm
Static tipping load:	straight	12060 kg	12015 kg	12130 kg
	40° full turn	10330 kg	10290 kg	10405 kg
Breakout force	166 kN	173 kN	180 kN	
Operating weight	18530 kg	18570 kg	18450 kg	

*At the end of tooth or bolt on cutting edge (B.O.C.).

All dimensions, weights, and performance values based on SAE J732c and J742b standards.

Static tipping load and operating weight shown include lubricant, coolant, full fuel tank, ROPS cab, and operator. Machine stability and operating weight affected by counterweight, tire size, and other attachments.

Apply the following weight changes to operating weight and static tipping load.



BUCKET SELECTION GUIDE

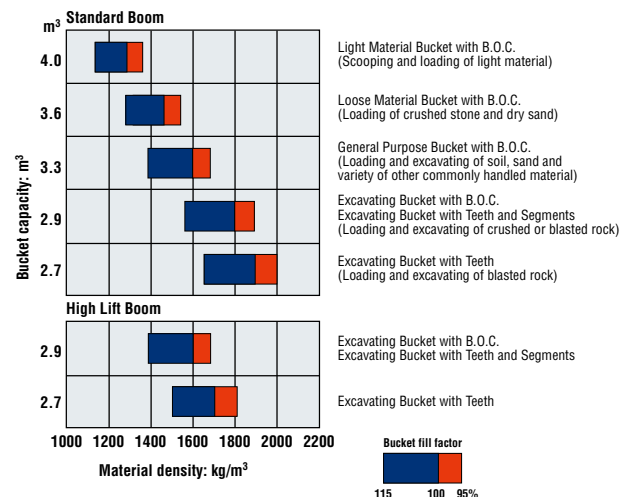



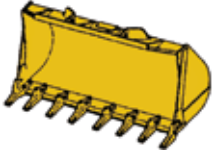
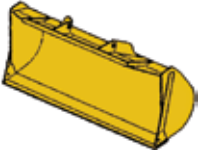

BUCKETS & ATTACHMENTS

■ Buckets

Type	Feature	Image
Stockpile Bucket	This bucket is used for loading stockpile products, such as crushed rock and construction materials.	
Excavating Bucket	This bucket is used for excavating and loading blasted rock on rock crushing job sites, or for excavating natural ground. It has a flat-blade, straight cutting edge, and provides superior rigidity and wear resistance.	
Loose/Light Material Bucket	This bucket is used for loading materials with comparatively light specific gravity. It is based on the general purpose bucket, with a lengthened cutting edge and width to give increased capacity.	

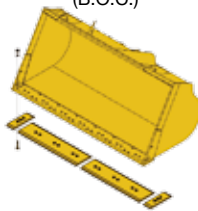
■ Cutting Edges and Teeth

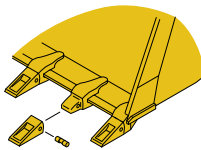
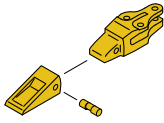
Type	Feature	Image	
Cutting Edges	This edge is made for use in loading loose sand and soil, or for loading stockpiled materials. It is bolted to the leading edge of general purpose buckets and may be detached and reversed. The cutting edges are manufactured from especially heat treated, high tension steel, and since they are reversible, both edges can be used. This effectively doubles their working life.	<p>Bolt on Cutting edges (B.O.C.)</p> 	<p>Segment Edges (SE)</p> 
Teeth (Bolt on type)	These teeth are suitable for loading or excavation of piles of earth or sand, blasted rock, and jobs in the field that involve digging into the side of slopes. The special heat treated, tensile strength steel alloy used in their production assures that they will wear and have a long service life.		
Teeth (Tip type)	These teeth tips which are attached to an adapter that is welded or bolted to the bucket edge. This means that an interchangeable part, the tooth tip, absorbs most of the wear and protects the actual bucket edge. They give excellent performance when used to handle blasted rock, piles of earth and similarly heavy duty tasks.	<p>Welded adapter</p> 	<p>Bolt on adapter</p> 

■ Grapple

Type	Feature	Image
Log Grapple	This is a special log attachment for use with logs ranging from small-diameter short logs to large-diameter long logs. Its shape enables it to grip the log well with little rolling shock, and it is designed so that the center of gravity of the log is close to the machine body. This enables the machine to maintain its stability when loading and hauling.	



WEIGHT / DIMENSIONS

Tires or attachments	Operating weight	Tipping load straight	Tipping load full turn	Width over tires	Ground clearance	Change in vertical dimensions
	kg	kg	kg	mm	mm	mm
23.5-25-16PR (L-3)	0	0	0	2780	455	0
20.5-25-16PR (L-3)	-970	-770	-680	2695	390	-65
Install additional counterweight	+340	+900	+755			



STANDARD EQUIPMENT

ENGINE/POWER TRAIN:

- Engine, Komatsu SAA6D107E-1 diesel
- Service brakes, wet disc type
- Transmission, 4 forward and 4 reverse

ELECTRICAL SYSTEM:

- Alternator, 60 A
- Back-up alarm
- Back-up lamp
- Batteries, 2 x 12 V/136 Ah
- Directional signal
- Engine shut-off system, electric
- Starting motor, 24 V/5.5 kW

HYDRAULIC SYSTEM:

- 2-spool valve for boom and bucket controls
- Hydraulic driven fan with reverse rotation
- Lift cylinders and bucket cylinder

CAB:

- Auto shift transmission with mode select system
- Main monitor panel with Equipment Management Monitoring System
- PPC fingertip control, 2 levers
- Rear defroster (electric)
- Rear view mirror for cab
- Rear window washer and wiper
- ROPS/FOPS (ISO 3471/ISO 3449) cab
- Seat, air-suspension type with reclining
- Seat belt
- Steering wheel, tiltable, telescopic
- Sun visor

WORK EQUIPMENT:

- Boom kick-out
- Bucket positioner
- Counterweight
- Loader linkage with standard lift boom

OTHER EQUIPMENT:

- Front fender
- Fuel pre-filter with water separator
- Radiator mask, lattice type
- Tires (23.5-25-16PR, L-3 tubeless)



OPTIONAL EQUIPMENT

ENGINE/POWER TRAIN:

- Additional fuel filter with water separator
- Brake cooling system
- Engine pre-cleaner with extension
- Limited slip differential (F&R)
- Lock-up clutch torque converter

ELECTRICAL SYSTEM:

- 12 V converter
- Batteries, 2 x 12/140 Ah
- Battery disconnect switch

HYDRAULIC SYSTEM:

- 3-spool valve
- Hydraulic driven fan with automatic reverse rotation
- Secondary steering (ISO 5010)

CAB:

- Air conditioner
- AM/FM radio
- AM/FM stereo radio cassette
- Auto air conditioner
- Cab heater and defroster
- FNR directional change switch
- Joystick steering
- Multifunction mono-lever
- Seat, deluxe suspension seat

WORK EQUIPMENT:

- Additional counterweight
- Bucket teeth (bolt-on type)
- Bucket teeth (tip type)
- Counterweight for log
- Cutting edge (bolt-on type)
- High lift boom
- Log grapple
- Segment edges

OTHER EQUIPMENT:

- Electronically Controlled Suspension System
- Fire extinguisher
- Load meter
- Ordinary spare parts
- Power train guard
- Rear fender
- Rear under view mirror
- Tool kit
- Vandalism protection kit

KOMATSU TOTAL SUPPORT**Komatsu Total Support**

To keep your machine available and minimize operation cost when you need it, Komatsu Distributor is ready to provide a variety of supports before and after procuring the machine.

Fleet recommendation

Komatsu Distributor can study the customer's job site and provide the most optimum fleet recommendation with detailed information to meet all of your application needs when you are considering to buy new machines or replace the existing ones from Komatsu.

Product support

Komatsu Distributor gives the proactive support and secures the quality of the machinery that will be delivered.

Parts availability

Komatsu Distributor is available for emergency inquiry by the customers for genuine, quality guaranteed Komatsu parts.

Technical support

Komatsu product support service (Technical support) is designed to help customer. Komatsu Distributor offers a variety of effective services to show how much Komatsu is dedicated to the maintenance and support of Komatsu machine.

- Preventive Maintenance (PM) clinic
- Oil & Wear analysis program

Repair & maintenance service

Komatsu Distributor offers quality repair and maintenance service to the customer, utilizing and promoting Komatsu developed programs.

Komatsu Reman (Remanufactured) components

Komatsu Reman products are the result of the implementation of the Komatsu global policy which establishes and agrees to reduce the owning, operating and total Life Cycle Costs (LCC) to Komatsu's customer through high quality, prompt delivery and competitively priced in own remanufactured products (QDC).



